

# GOVT. DEGREE COLLEGE – GAMBHIRAOPET

## DEPARTMENT OF ENGLISH

### AWARENESS PROGRAMME

Unique SI No	Date	Title of the Awareness	Resource Person	No of Students Attended	Remarks
<b>2021-2022</b>					
1	10-05-2022	What after Graduation? Career Building Up	<b>P. Krishna Murthy</b> Lecturer in English <i>GDC-Gambhiraopet</i> <b>Y. Anjaneyulu</b> Lecturer in English <i>GDC-Gambhiraopet</i>	55	
<b>Total Number of Events in the Year 2021-2022: 01</b>					
<b>2020-2021</b>					
2	14-12-2020	Awareness on TASK	<b>Y. Anjaneyulu</b> Lecturer in English <i>GDC-Gambhiraopet</i>	42	
<b>Total Number of Events in the Year 2020-2021: 01</b>					
<b>2019-2020</b>					
3	26-02-2020	<i>Career Guidance:</i> International Language & Opportunities	<b>Y. Anjaneyulu</b> Lecturer in English <i>GDC-Gambhiraopet</i>	41	
<b>Total Number of Events in the Year 2019-2020 : 01</b>					
<b>2018-2019</b>					
4	27-08-2018	Awareness on <i>Career Guidance: Interview Skills Body Language</i>	<b>Y. Anjaneyulu</b> Lecturer in English <i>GDC-Gambhiraopet</i>	45	
5	12-09-2018	Awareness on <i>Semester Examinations</i>	<b>Y. Anjaneyulu</b> Lecturer in English <i>GDC-Gambhiraopet</i>	48	
<b>Total Number of Events in the Year 2019-2020 : 02</b>					
<b>Grand Total of All Five Academic Years : 05</b>					

Date: 10-5-2022



Sri P. Dass garu principal of this college appreciating the Department of English to conduct Awareness Programme on 'What after Graduation? – Career Building Up



In-charge of the Department of English Sri P. Krishna Murthy garu delivering lecture on 'What after Graduation? Career Building Up

Date: 10-5-2022



IQAC Co-ordinator Sri B. Bixmaiah garu sharing his views on the topic



Sri Y. Anjaneyulu Lecturer in English expressing his thoughts on English bright career after completion of Graduation

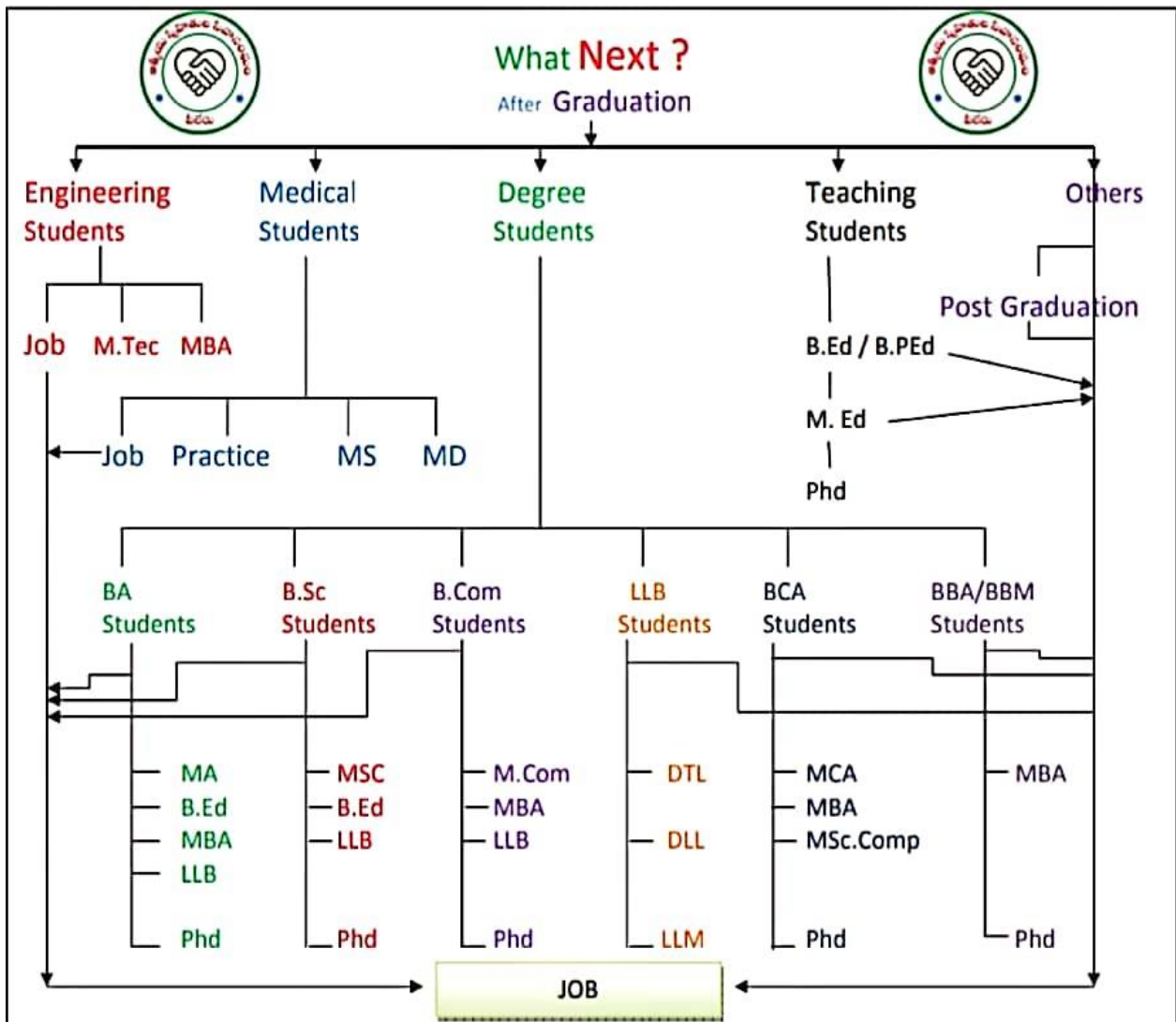

Post Graduation Course	Eligibility
MA Telugu	Any degree with one subject Telugu
MA English	Any degree with one subject English
MA Hindi	Any degree with one subject Hindi
MA Economics	BA with Economics one of the sub.
MA History	BA with History one of the sub.
MA Sociology	BA
MA Political Sci.	BA
MA Public Adm.	BA.
MS. Public rel.	BA
M.Sc Computers	B.Sc Comp / B.Com Comp / BA Comp / BCA
M.Com	B.Com/ BA with Commerce one of the subject.
MCA	BA/B.Sc with Maths.
MBA	Any degree
MA Archaeolog	BA

Post Graduation Course	Eligibility
M.Sc Maths	B.Sc / BA with one subject Maths
M.Sc Chemistry	B.Sc with Chemistry
M.Sc Botany	B.Sc with Botany
M.Sc Zoology	B.Sc with Zoology
M.Sc Physics	B.Sc with Physics
M.Sc Home Sci.	B.Sc with Botany + Zoology
M.Sc Anthrop	B.Sc with Zoology / BA
M.Sc Psychology	Any degree
M.Sc Bio-Chemis	B.Sc with one subject Chemi
M.Sc Bio-Tecno	B.Sc with one subject Bio-Tecnology
M.Sc Micro biolo	B.Sc with Zoology
MSc Virology	B.Sc with Zoology
MLIC	BLIC
LLM	BL / LLB

**The Chart shows that After Graduation? Career Building Up**

### Undergraduate Courses

- ✎ Bachelor Hotel Management and Catering Technology(B.H.M.C.T)
- ✎ Bachelor of Architecture (B.Arch)
- ✎ Bachelor of Arts (B.A)
- ✎ Bachelor of Ayurvedic Medicine and Surgery(B.A.M.S)
- ✎ Bachelor of Business Administration (B.B.A)
- ✎ Bachelor of Business Management (BBM)
- ✎ Bachelor of Business Studies(B.B.S)
- ✎ Bachelor of Commerce (B.Com)
- ✎ Bachelor of Computer Applications (B.C.A)
- ✎ Bachelor of Dental Surgery (B.D.S)
- ✎ Bachelor of Design(B.Des)
- ✎ Bachelor of Education (B.Ed)
- ✎ Bachelor of Elementary Education(B.EL.Ed)
- ✎ Bachelor of Engineering (B.E) / Bachelors of Technology (B.Tech)
- ✎ Bachelor of Fashion Technology (B.F.Tech)
- ✎ Bachelor of Fine Arts(B.F.A)
- ✎ Bachelor of Homeopathic Medicine & Surgery (B.H.M.S)
- ✎ Bachelor of Hospitality and Tourism Management(B.H.T.M)
- ✎ Bachelor of Hotel Management(B.H.M)
- ✎ Bachelor of Law (LL.B)
- ✎ Bachelor of Medicine Bachelor of Surgery (M.B.B.S)
- ✎ Bachelor of Optometry and Vision Science(B.Optom)
- ✎ Bachelor of Pharmacy (B.Pharma)
- ✎ Bachelor of Physical Education (B.P.Ed)
- ✎ Bachelor of Physiotherapy(B.P.T)
- ✎ Bachelor of Science Education(B.S.E)
- ✎ Bachelor of Science in Education(B.Sc.Ed)
- ✎ Bachelor of Science (B.S / B.Sc)
- ✎ Bachelor of Siddha Medical Sciences(B.S.M.S)
- ✎ Bachelor of Socio Legal Sciences Bachelor of Laws(B.S.L.LL.B)
- ✎ Bachelor of Tourism Administration(B.T.A)
- ✎ Bachelor of Unani Medicine & Surgery(B.U.M.S)
- ✎ Bachelor of Veterinary Science (B.V.Sc)

### Integrated Courses

- ✎ Bachelor of Arts Bachelor of Education (B.A B.Ed)
- ✎ Bachelor of Arts Bachelor of Law (B.A LLB)
- ✎ Bachelor of Business Administration Bachelor of Law (BBA LLB)
- ✎ Bachelor of Science Bachelor of Education (B.Sc B.Ed)
- ✎ Bachelor of Science Degree in Nursing (B.Sc Nursing)

### Postgraduate Courses

- ✎ Masters of Architecture (M.Arch)
- ✎ Masters of Arts (M.A)
- ✎ Masters of Business Administration (MBA)
- ✎ Master of Commerce (M.Com)
- ✎ Masters of Computer Application (MCA)
- ✎ Masters of Education (M.Ed)
- ✎ Masters of Law (LLM)
- ✎ Master of Philosophy (M.Phil)
- ✎ Masters of Science (M.Sc)
- ✎ Masters of Technology (M.Tech)
- ✎ Post Graduate Diploma in Management (PGDM)
- ✎ PG Medical (MD / MS / DM / MCh)
- ✎ PG Dental (MDS)

### More

- ✎ Doctor of Philosophy (Ph.D)
- ✎ Integrated / Dual Degree
- ✎ Diploma
- ✎ PG Diploma

**The Chart shows that After Graduation which type of courses are available**

Date: 14-12-2020

(2020-2021)



Mr. Y. Anjaneyulu, Lecturer in Englis of this college arranged an Awareness Programme on TSKC

Date: 14-12-2020



Students and faculty participated very interestingly



Students are participated enthusiastically on TASK Programme



Mr. Y. Anjaneyulu Lecturer in English and In-charge of the Department of English delivering lecture on Career Guidance to the students about International Language



M. Nikitha B.Sc.(B.Z.C.) – I year expressing her views on International Language



L. Manjusha B.Sc.(B.Z.C.) – I year delivering her thoughts on International Language

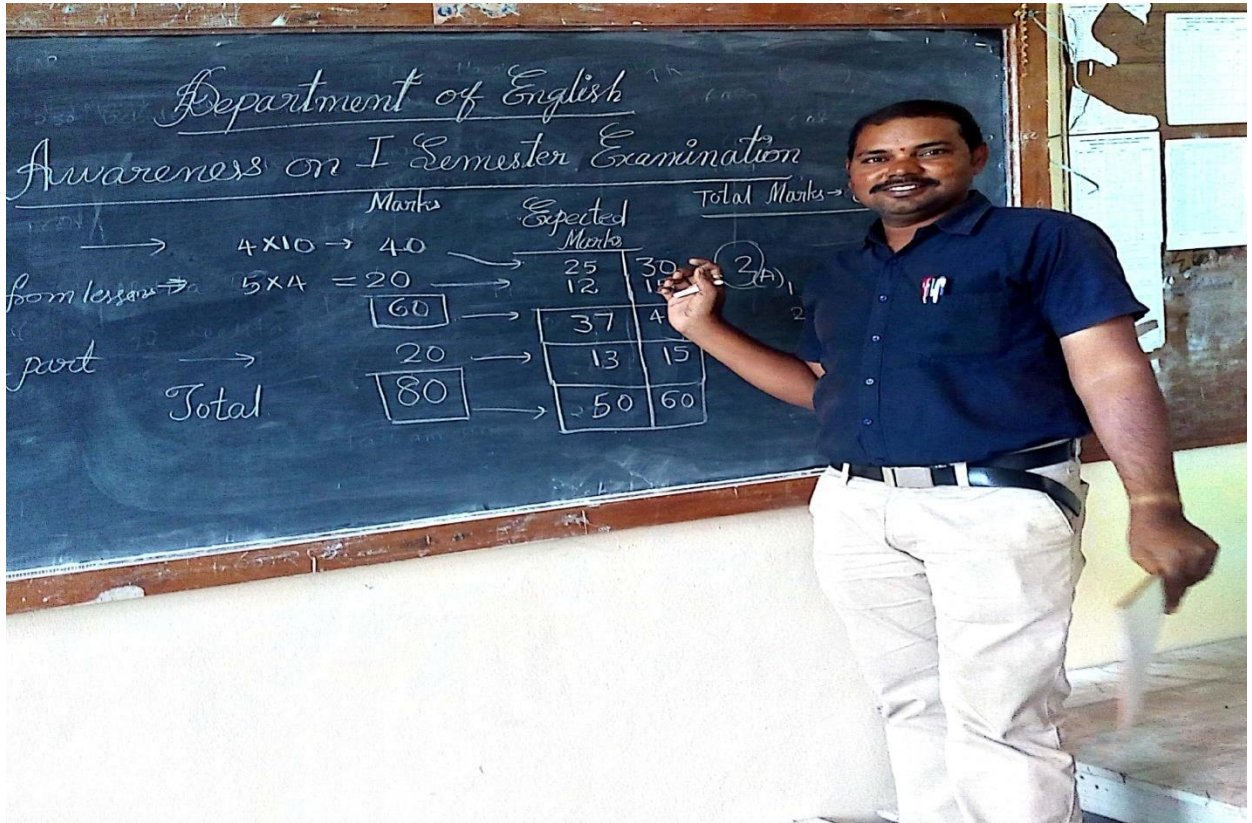

Mr. Y. Anjaneyulu, Lecturer in English of this college delivering 'Awareness on Semester Examinations' for all the students of B.A., B.Com. & B.Sc.



Students are enthusiastically participated to clarify their doubts.



**GOVERNMENT DEGREE COLLEGE  
GAMBHIRAOPET  
RAJANNASICILLA**

DEPARTMENT OF COMMERCE

2018-2019

AWARENESS PROGRAMME ON FINANCIAL  
LITERACY AND DIJITAL FINANCIAL LITERACY

Govt Degree college - Gambhiraopet, Rajanna Sircilla  
Department of commerce



\* Permission Letter \*

7/08/2018

To,  
The principal,  
GDC Gambhiraopet.

Sir,

Subj:- Department of Commerce - Request to give permission for the conducting of Awareness programme on Financial Literacy and Digital Financial Awareness on

It is submitted to your kind notice that the Faculty of the Department of Commerce are willing to conduct Awareness programme on Financial Literacy and Digital Financial Awareness on

Hence, it is Request to give permission for conducting the above cited programme

Thanking you sir.

Yours faithfully

K. Mahesh

Department of Commerce  
In-charge

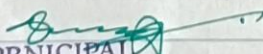
  
PRINCIPAL  
GOVT. DEGREE COLLEGE  
GAMBHIRAOPET-505304  
RAJANNA-SIRCILLA (DIST) T.S.

Govt Degree college - Gambhirapet, Rajanna Sircilla  
Department of Commerce

## Notice

23

8/08/2018

All the students of this college belonging to B.com  
(General) & (Computer Application) of 1st, 2nd year, and  
3rd year students that the staff of the Department  
of Commerce are going to conduct an Awareness  
programme on Financial Literacy and Digital Finance  
on 9-08-2018 at 12:00

Hence, all the students are instructed  
to attend the programme without fail

- 1) B.com - 1st year: X-mahesh
- 2) B.com - 2nd year: Epp.
- 3) B.com - 3rd year: Shrishe

Principal

PRINCIPAL  
GOVT. DEGREE COLLEGE  
GAMBHIRAOPET-505304  
RAJANNA SIRICILLA (DIST) T.S.

Govt Degree college - Gambhirapet, Rajanna Street,  
24 Department of Commerce



Govt Degree college - Gambhiraopet, Rajanna sircilla  
Department of Commerce

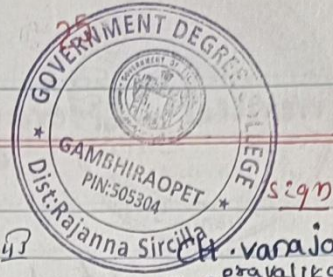

<u>S.No</u>	<u>Name of the student</u>	<u>Group</u>	<u>Signature</u>
01.	CH. Vanaja	B.com-I	CH. Vanaja
02.	E. pravalika	"	E. pravalika
03.	G. Divya	"	G. Divya
04.	CH. Sai Kiran	B.com-II	CH. Sai Kiran
05.	MD. Sajed	"	MD. Sajed
06.	m. Divya	"	MD. Sajed
07.	G. Navitha	B.com-I	G. Navitha
08.	K. pooja	"	K. Pooja
09.	K. Navitha	"	K. Navitha
10.	A. Neelima	"	A. neelime
11.	L. swetha	"	L. swetha
12.	MD. Imranpasha	B.com-II	MD. Imranpasha
13.	m. Venkatesh	"	M. Venkatesh
14.	N. susmelha	"	N. susmelha
15.	P. Deepa	"	P. Deepa
16.	R. Vishnu prasad	"	R. Vishnu prasad
17.	T. Shiva kumar	B.com-II	T. Shiva kumar.
18.	m. prameela	B.com-I	M. Prameela.
19.	m. Rakesh	"	M. Rakesh
20.	R. vijaya	"	R. Vijaya
21.	Samreen	"	Samreen
22.	SD. Mushraf	"	SD. Mushraf
23.	N.K. Mahalaxmi	"	N.K. Mahalaxmi
24.	A. Anil	"	A. Anil

K. Mahesh  
Department of commerce  
Incharge

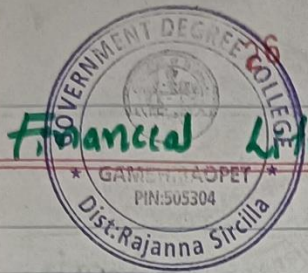

Report  
on

Govt. Degree college  
Gambhirapet  
Department of commerce

## Financial Literacy and Digital Finance

As notified earlier, the faculty of the Department of commerce have successfully conducted Awareness programme on Financial Literacy and Digital Finance on 9/8/2018. The faculty gave relevant inputs to the students. Later, the principal gave the message on Digitalization and Financial Literacy. The students also expressed their impression on the programme. On the whole, it has been conducted successfully and purposefully.

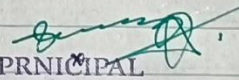
  
PRINCIPAL

GOVT. DEGREE COLLEGE  
GAMBHIRAPET-505304  
RAJANNA SIRCILLA (DIST) T.S.

**Government Degree College**

**Gambhiraopet**

**Rajannasircilla**

**Department of commerce**

**Pratima foundation**

**Training on skills development and vocational education**



Pratima foundation manager Geetha Reddy conducted this program on 7 January 2022 to create awareness among the youth in the Govt Degree college on various livelihood opportunities. training on skills development and vocational education (AC repair heavy vehicle driving mechanism medical lab courses ) as well as promoting self employment providing to get financial assistant.

## యువత జీవన నైపుణ్యాలతో పాటు వృత్తి నైపుణ్యాలు కలిగి ఉండాలి

- ప్రతిమ ఫౌండేషన్ మేనేజర్ వంగ గీతారెడ్డి

గంభీరావుపేట, జనవరి 7 (ప్రభన్యూస్): యువత జీవన నైపుణ్యాలతో పాటుగా వృత్తి నైపుణ్యాలు కలిగి ఉన్నప్పుడే ఆర్థిక పురోగతిని సాధించవచ్చని ప్రతిమ ఫౌండేషన్ మేనేజర్ గీతారెడ్డి అన్నారు. గంభీరావుపేట మండల కేంద్రంలోని ప్రభుత్వ డిగ్రీ కళాశాలలో శుక్రవారం విద్యార్థిని, విద్యార్థులకు వృత్తి, జీవన నైపుణ్యాలపై గీతారెడ్డి అవగాహన కల్పించారు. ఈ సందర్భంగా ఆమె మాట్లాడుతూ.. యువత జీవన నైపుణ్యాలతో పాటుగా వృత్తి నైపుణ్యాలు కలిగి ఉన్నప్పుడే ఆర్థిక పురోగతిని సాధించవచ్చని, చదువుతో పాటుగా ఇష్టమైన పనిలో నైపుణ్యాన్ని సాధించాలని ప్రతిమ ఫౌండేషన్ సహకారంతో నాగార్ శిక్షణ కేంద్రంలో బెడ్ సైడ్ నర్సింగ్, అసిస్టెంట్ ఎలక్ట్రిషియన్ సెల్స్ అసిస్టెంట్ ఎలక్ట్రిషియన్ బైక్ మెకానిక్, మహిళలకు కుట్టు



అవగాహన కల్పిస్తున్న ప్రతిమ ఫౌండేషన్ మేనేజర్ గీతారెడ్డి

మిషన్ వంటి పలు కోర్సుల్లో ఉచిత హాస్టల్ వసతి సౌకర్యంతో శిక్షణ అందిస్తున్నట్లు తెలిపారు. యువత ఇలాంటివి సద్వినియోగం చేసుకుని ముందుకెళ్ళాలని సూచించారు. ఆర్గనైజర్ వెంకట లక్ష్మి, కళాశాల ప్రిన్సిపాల్ పిట్ల దాసు, వైస్ ప్రిన్సిపాల్ శ్రీవల్లి, విద్యార్థిని విద్యార్థులు పాల్గొన్నారు.

## Young people should have life skills as well as vocational skills

-Pratima Foundation Manager Vanga Geeta Reddy

Gambhiraupeta, January 7 (Prabhanyune): Youth life is not Financial only when one has professional skills along with virtues Image Foundation Manager Gita says progress can be made Reddy said. Government in the center of Gambhiraupetamandala Degree College Friday student, career for students Geeta Reddy briefed on life skills. This is Rbanga she said ... with the life skills of youth Economic progress only when one has professional skills Achievable, skillful in hobbies along with reading Naga in collaboration with Pratima Foundation to achieve Jyan Bed Side Nursing, Assistant Electrification at Rum Training Center Sales Assistant Electric Bike Mechanic, Sewing for Women



Awareness is provided by Pratima Foundation Manager Geeta Reddy

With free hustle and bustle accommodation in Mission Corps Shi said offering the moment. The youth are like Sadhvi Advised to get deployed and move on. Arthanai Jar Venkata Lakshmi, College Principal Pitla Dasa, Vice Principal Paul Srivalli, student participated.





**Ignorance and neglect in our country**  
Many people have the rights given to us by the Constitution of India.  
**Unable to know responsibilities. In backward areas**  
For the living poor, the government is doing for their welfare  
**Not aware of any program, for such people**  
We run awareness programs with the participation of all people  
We will manage. Every citizen has his responsibilities  
We hope to maintain. Both rights and responsibilities  
Full development is possible only when walking hand in hand.

### On expertise, vocational education Awareness and training

Various livelihoods for the youth in the villages  
On opportunities **Awareness raising**.  
Training in skills and vocational training (e.g. A.C. Repairing, driving heavy vehicles, Training in Mechanism, Medical Labs Course Mo I) such as promoting self-employment  
At the maximum level along with different programs  
On business practices that bring success  
Awareness seminars are also organized  
In the villages For the youth Better employment  
Paving the way, without any problem  
To obtain financial assistance from banks  
To help. The purpose of our foundation).



PRATHIMA FOUNDATION

14

Training and Employment opportunities Awareness programme

Prathima Foundation Manager Geetha Reddy conducted this programme on 01/01/2022 to create awareness among the youth in the Govt Degree college on various livelihood opportunities. Training on skills Development and vocational education (A/c repairs, heavy vehicle driving, mechanism, medical Lab courses). as well as promoting self employment providing to help get financial assistance.

*Signature*

Principal  
G.D.C.Gambhiraopet  
Dist:Rajanna Sireilla-505304

యువత జీవన నైపుణ్యాలతో పాటు వృత్తి నైపుణ్యాలు కలిగి ఉండాలి

- ప్రతిమ ఫౌండేషన్ మేనేజర్ వంగ గీతారెడ్డి

గంధీరావుపేట, జనవరి 7 (ప్రభుత్వం): యువత జీవన నైపుణ్యాలతో పాటుగా వృత్తి నైపుణ్యాలు కలిగి ఉన్నప్పుడే ఆర్థిక పురోగతిని సాధించవచ్చని ప్రతిమ ఫౌండేషన్ మేనేజర్ గీతారెడ్డి అన్నారు. గంధీరావుపేట మండల కేంద్రంలోని ప్రభుత్వ డిగ్రీ కళాశాలలో శుభ్రవారం విద్యార్థిని, విద్యార్థులకు వృత్తి, జీవన నైపుణ్యాలపై గీతారెడ్డి అవగాహన కల్పించారు. ఈ సందర్భంగా ఆమె మాట్లాడుతూ, యువత జీవన నైపుణ్యాలతో పాటుగా వృత్తి నైపుణ్యాలు కలిగి ఉన్నప్పుడే ఆర్థిక పురోగతిని సాధించవచ్చని, చదువుతో పాటుగా ఇష్టమైన పనిలో నైపుణ్యాన్ని సాధించాలని ప్రతిమ ఫౌండేషన్ సహకారంతో నాగార్ల శిక్షణ కేంద్రంలో ఐడ్ సైడ్ సర్కింగ్, ఆనిస్సెంట్ ఎలక్ట్రిషియన్ సెల్స్ అనిస్సెంట్ ఎలక్ట్రిషియన్ టైల్ మెకానిక్, మహిళలకు కుట్టు



అవగాహన కల్పిస్తున్న ప్రతిమ ఫౌండేషన్ మేనేజర్ గీతారెడ్డి

మిషన్ వంటి పలు కోర్సుల్లో ఉచిత హస్తాల్ వసతి సౌకర్యంతో శిక్షణ అందిస్తున్నట్లు తెలిపారు. యువత ఇలాంటివి సద్వినియోగం చేసుకుని ముందుకెళ్ళాలని సూచించారు. ఆర్గనైజర్ వెంకట లక్ష్మి, కళాశాల ప్రిన్సిపాల్ పిట్ల దాసు, టైల్ ప్రిన్సిపాల్ శ్రీవల్లి, విద్యార్థిని విద్యార్థులు పాల్గొన్నారు.



EDC programme.

S. NO.	Student Name	H. NO.	Signature
	T. Nikitha	20077086468018	T. Nikitha.
	P. Shruithija	210770864681031	P. Sufi
	L. Ashwini	210770864681021	L. Ay
	S. Chandana	210770864681039.	S. Chandana
	A. Yaswanth	21077086468104	A. Yaswanth
	V. Shivakumar	210770864681045	V. Shiva
	M. Shruthe	210770864681026	M. Sy
	M. Dileep	210770864681023	M. Dileep.
	P. Raj kumar	210770864411003	P. Raj kum
	N. Divya		
	Saniya	20077086402062	N. Divya
	N. Prathyusha	20077086402084	Saniya
	M. Mounika	20077086402064	N. Prathyusha
	Sk. Mubeen pasha	20077162402111	M. Mounika
	A. Nikhil kumar	20077086402087	Sk. Mubeen pasha
	D. Ranjith kumar	20077086402002	A. Nikhil kumar
	B. praneeth	20077086402023	D. Ranjith kumar.
	K. Rekha	20077086402015	B. praneeth.
	G. Sailatha	210770864021056	K. Rekha
	S. Sandhya.	210770864021044	G. Sailatha
	A. Ganeshevar.	210770864021093	Sandhya, S.
	N. Rakshitha	210770864021008	A. Ganeshevar.
		210770864021070	N. Rakshitha

PRINCIPAL  
GOVT. DEGREE COLLEGE  
GAMBHIRAOPET-505300  
RAJANNA SIRCILLA (DIST) T.S.



Student Name	H.NO.	Sign
Kavya Dharani	20077089402018	[Signature]
sheelam. Nikhitha	20077089402025	S. Nikhitha
Jampelly Bhavisha	20077089402042	J. Bhavisha
Pilla, Sony	20077086402076	P. Sony
manda. Aparna	20077089402004	m. Aparna
Domakonda shirisha	20077089402025	D. Shirisha
Nagarapu Ishwarya.	20077086402063	N. Ishwarya
Paka Ruchitha.	20077086402068	P. Ruchitha.
Dyanaboina Bhavya.	20077086402026	D. Bhavya
chattaboina Archana	20077086402018	Ch. Archana.
Nagarapu. Divya	20077086402061	N. Divya
Eraveni Bhavana	20077086402030	E. Bhavana
Eraboina Ruchitha	20077086402028	E. Ruchitha
Pothireddy Rekha	210770864681035	P. Rekha
Akaram Sangeetha	210770864681002	A. Sangeetha
Bommena sandya	210770864681009	B. sandya
Pogula Soumya	210770864681033	P. Soumya.
Mende Sandhya	200770864681013	M. Sandhya
Bushi Nirosha	20077086468003	B. Nirosha
methuku Dimesh	20077086462054	m. Dimesh

PRINCIPAL  
GOVT. DEGREE COLLEGE  
GAMBHIRAOPET-505304  
RAJANNA SIRCILLA (DIST. T.S.)

Government Degree College, Gambhiraipet  
Department of Political Science

59

CAREER GUIDANCE PROGRAMME  
Academic Year - 2018-19

PERMISSION LETTER  
Date: 15-09-2018



TO

The Principal  
Government Degree College  
Gambhiraipet - 505304.

Respected Sir,

Subj: Department of Political Science  
seeking permission to conduct "CAREER-  
GUIDANCE" PROGRAMME in our college  
Req. Req.

Dear Sir,

We the Department of Political Science  
would like to bring to your kind notice that  
the Department of Political Science would  
like to conduct "CAREER GUIDANCE" PROGRAMME  
it is betterment of All BA students.

Hence, we request you to permit  
us to or conduct the programme.

Thanking you Sir

Yours Faithfully

Dhanraj

P. Dhanraj  
Lecturer in Political  
Science.

CAREER GUIDANCE PROGRAMM  
Academic Year: 2018-19

CIRCULAR

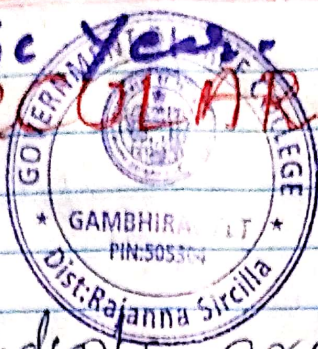

Date: 15.09.2018

All the students are here by informed that we, the Department of Political Science of GDC, Gambhira Pet, planning to conduct "CAREER GUIDANCE" programme on i.e. 18.09.2018 at 11:00 A.M.

Hence all B.A students are Requested to Attend without fail.

B.A. I Year

II Year - Anjanappa

III Year - BRMP

Dharmaji

Incharge/coordinator

  
PRINCIPAL  
GOVT. DEGREE COLLEGE  
GAMBHIRAOPET-505304  
RAJANNA SIRCILLA (DIST).S.

CAREER GUIDANCE

Academic year 2018-19

18.09.2018

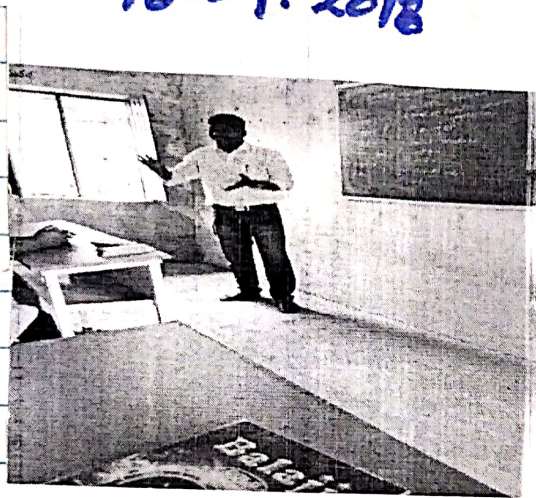

Dr. P. Dharmapathi

→ providing an important inputs for

State

Group - I

Group - II

Exam

in

Andhra polity

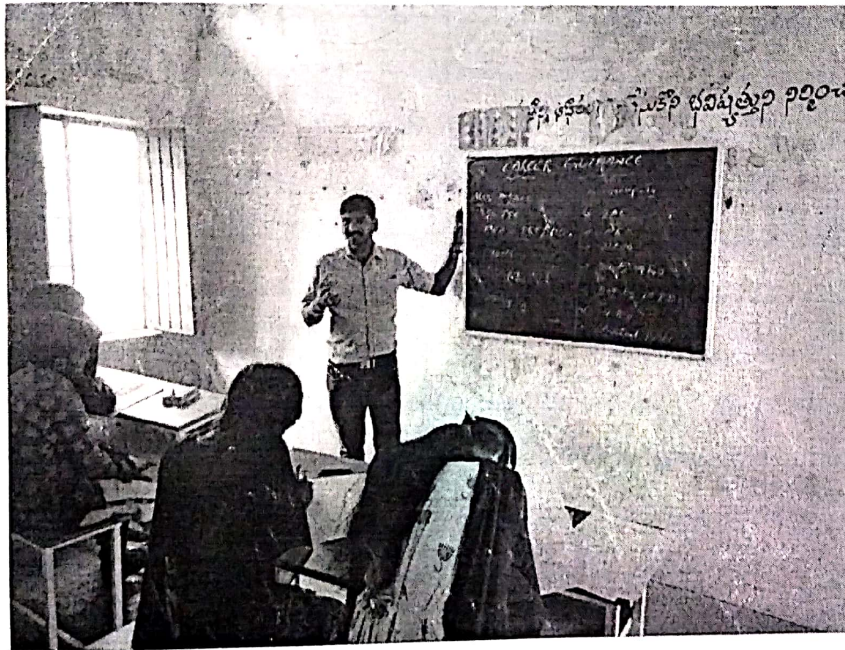

Students	Sigaram	Group	Year
1) Ch. Sujan	Ch. Sujan	B.A (HEP)	1st year
2) K. Raviteja	K. Ravu	B.A. (HEP)	2nd year
3) B. Raju	B. Raju	BA HEP	1st year
4) G. Meena	Meena	BA HEP	1st year
5) R. Venkataswaraiah	R. V. Swaraiah	BA (HEP)	1st year
6) R. Nareesh	R. Nareesh	(B.A)(H.E.P.)	3rd year
7) D. Soumya	D. Soumya	(B.A) H.E.P.	3rd year
8) G. Swetha	G. Swetha	(B.A) H.E.P.	4th year
9) J. Sony	J. Sony	(B.A) H.E.P.	1st year

Dharmapathi



Student name	Signature	Course	Year
10) S. Navitha	S. Navitha	B.A (H.E.P)	I <sup>st</sup> year.
11) A. Aitai	A. Aitai	B.A (H.E.P)	I <sup>st</sup> year
12) M. Kalyani	M. Kalyani	BA (H.E.P)	II <sup>nd</sup> year
13) M. Latha	M. Latha	BA (H.E.P)	II <sup>nd</sup> year
14) M.D. Someha	M.D. Someha	BA (H.E.P)	II <sup>nd</sup> year
15) N. Nirmala	N. Nirmala	BA (H.E.P)	II <sup>nd</sup> year
16) S. Mahandor	S. Mahandor	B.A (H.E.P)	II <sup>nd</sup> year

1) B.Com  
Lect in Zoology

2) Anjireddy

3) Bharu  
Dharamagni  
Lecturer in  
Political Science.

  
PRINCIPAL  
GOVT. DEGREE COLLEGE  
GAMBHIRACPET-505304  
RAJANNA-SIRCILLA (DIST) T.S.



# **GOVERNMENT DEGREE COLLEGE, GAMBHIRAOPET**

**RAJANNA SIRCILLA**

**DEPARTMENT OF HISTORY**

**CAREER GUIDANCE 2018-2019**

CAREER GUIDANCE  
Department of History

Date: 14/03/19

13

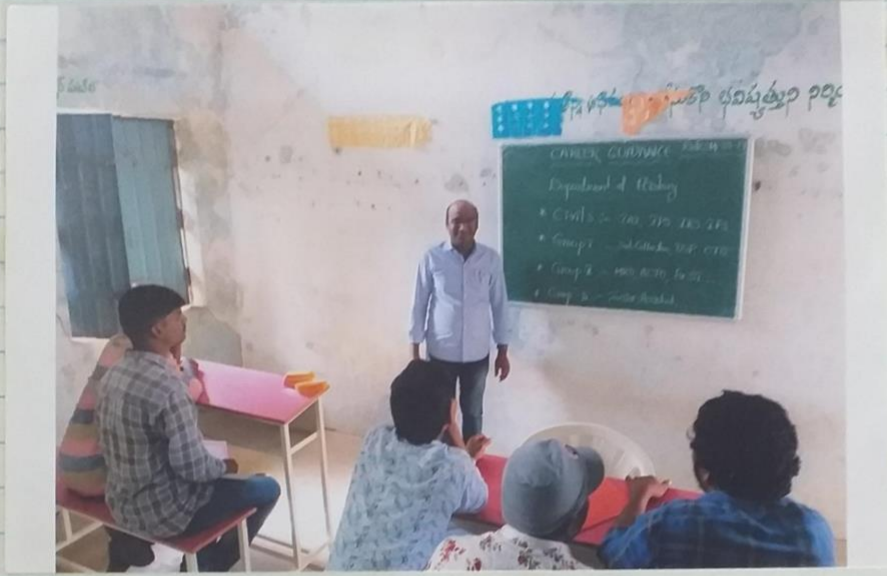

తేదీ 14-03-2019 రోజున గాంధీరావుపేట జిల్లా కళాశాలలో "CAREER GUIDANCE" అనేకార్యక్రమం నిర్వహించారు. ఇందులో జిల్లా కార్యకర్తల Studies గురించే మరియు ప్రధానంగా ఉచితంగా పాఠాధికారుల Competitive Exams [Civils, Group-I, Group-II, Group-IV] గురించే వివరించారు.

Student Names:-

- |                |                    |
|----------------|--------------------|
| 1) Ch. Sujan   | 8) Ch. Rekha       |
| 2) G. Haridas  | 9) P. Savi Ma.     |
| 3) M. Das      | 10) K. Rekha       |
| 4) K. Raviteja | 11) A. Swapna      |
| 5) T.S. Raju   | 12) P. Saritha     |
| 6) G. Vamsi    | 13) B. Bikshapathi |
| 7) B. Praveen  | 14) M. Hanra       |
|                | 15) R. Venkatesh   |

  
PRINCIPAL  
GDC, Gambhiraopet  
Dist: Rajanna Sircilla-505304



GOVERNMENT DEGREE COLLEGE, GAMBHIRAOPET  
RAJANNA SIRCILLA DIST  
TELANGANA

**DEPARTMENT OF PHYSICS**

PERMISSION LETTER

Date:13-11-2021.

To  
The Principal,  
Government Degree College,  
Gambhiraopet,  
Rajanna Sircilla Dist.-506304



Respected Sir,

Sub: - Department of Physics - Seeking Permission to conduct career guidance in our college Request-Reg.

-o0o-

*Permitted*  
*[Signature]*

We the Department of Physics would like to conduct career guidance programme in our college for the welfare of our students on 15-11-2021 to create awareness among them regarding Higher education and Job Opportunities.

Hence, we request you to permit us to conduct the above programme .

Thanking you sir,

Yours faithfully  
*N. Adivishnu*  
N.Adivishnu  
In-charge  
Department of Physics

GOVERNMENT DEGREE COLLEGE, GAMBHIRAOPET  
RAJANNA SIRCILLA DIST  
TELANGANA

**DEPARTMENT OF PHYSICS**

CIRCULAR

Date: 14-11-2021.

All the students are here by informed that we, the Department of Physics is going to  
Conduct career guidance awareness programme on 15-11-2021 in our college.



*M. Adivishnu*  
Course coordinator

*[Signature]*  
Principal  
PRINCIPAL  
GOVT. DEGREE COLLEGE  
GAMBHIRAOPET-505304  
RAJANNA SIRCILLA (DIST) T.S.

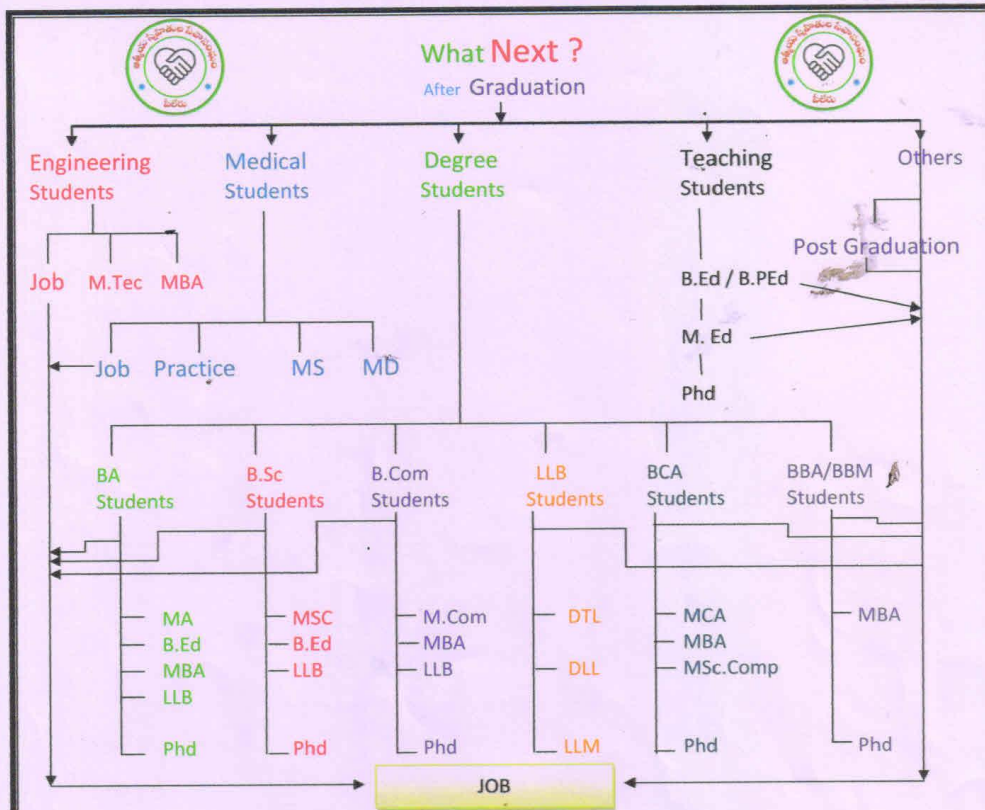

Post Graduation Course	Eligibility
MA Telugu	Any degree with one subject Telugu
MA English	Any degree with one subject English
MA Hindi	Any degree with one subject Hindi
MA Economics	BA with Economics one of the sub.
MA History	BA with History one of the sub.
MA Sociology	BA
MA Political Sci.	BA
MA Public Adm.	BA.
MS. Public rel.	BA
M.Sc Computers	B.Sc Comp / B.Com Comp / BA Comp / BCA
M.Com	B.Com/ BA with Commerce one of the subject.
MCA	BA/B.Sc with Maths.
MBA	Any degree
MA Archaeolog	BA

Post Graduation Course	Eligibility
M.Sc Maths	B.Sc / BA with one subject Maths
M.Sc Chemistry	B.Sc with Chemistry
M.Sc Botany	B.Sc with Botany
M.Sc Zoology	B.Sc with Zoology
M.Sc Physics	B.Sc with Physics
M.Sc Home Sci.	B.Sc with Botany + Zoology
M.Sc Anthrop	B.Sc with Zoology / BA
M.Sc Psychology	Any degree
M.Sc Bio-Chemis	B.Sc with one subject Chemi
M.Sc Bio-Tecno	B.Sc with one subject Bio-Tecnology
M.Sc Micro biolo	B.Sc with Zoology
MSc Virology	B.Sc with Zoology
MLIC	BLIC
LLM	BL / LLB



  
**PRINCIPAL**  
 GOVT. DEGREE COLLEGE  
 GAMBHIRAOPET-505304  
 RAJANNA SIRCIlla (DIST).S.

### Undergraduate Courses

- Bachelor Hotel Management and Catering Technology(B.H.M.C.T)
- Bachelor of Architecture (B.Arch)
- Bachelor of Arts (B.A)
- Bachelor of Ayurvedic Medicine and Surgery(B.A.M.S)
- Bachelor of Business Administration (B.B.A)
- Bachelor of Business Management (BBM)
- Bachelor of Business Studies(B.B.S)
- Bachelor of Commerce (B.Com)
- Bachelor of Computer Applications (B.C.A)
- Bachelor of Dental Surgery (B.D.S)
- Bachelor of Design(B.Des)
- Bachelor of Education (B.Ed)
- Bachelor of Elementary Education(B.EL.Ed)
- Bachelor of Engineering (B.E) / Bachelors of Technology (B.Tech)
- Bachelor of Fashion Technology (B.F.Tech)
- Bachelor of Fine Arts(B.F.A)
- Bachelor of Homeopathic Medicine & Surgery (B.H.M.S)
- Bachelor of Hospitality and Tourism Management(B.H.T.M)
- Bachelor of Hotel Management(B.H.M)
- Bachelor of Law (LL.B)
- Bachelor of Medicine Bachelor of Surgery (M.B.B.S)
- Bachelor of Optometry and Vision Science(B.Optom)
- Bachelor of Pharmacy (B.Pharma)
- Bachelor of Physical Education (B.P.Ed)
- Bachelor of Physiotherapy(B.P.T)
- Bachelor of Science Education(B.S.E)
- Bachelor of Science in Education(B.Sc.Ed)
- Bachelor of Science (B.S / B.Sc)
- Bachelor of Siddha Medical Sciences(B.S.M.S)
- Bachelor of Socio Legal Sciences Bachelor of Laws(B.S.L.LL.B)
- Bachelor of Tourism Administration(B.T.A)
- Bachelor of Unani Medicine & Surgery(B.U.M.S)
- Bachelor of Veterinary Science (B.V.Sc)

### Integrated Courses

- Bachelor of Arts Bachelor of Education (B.A B.Ed)
- Bachelor of Arts Bachelor of Law (B.A LLB)
- Bachelor of Business Administration Bachelor of Law (BBA LLB)
- Bachelor of Science Bachelor of Education (B.Sc B.Ed)
- Bachelor of Science Degree in Nursing (B.Sc Nursing)

### Postgraduate Courses

- Masters of Architecture (M.Arch)
- Masters of Arts (M.A)
- Masters of Business Administration (MBA)
- Master of Commerce (M.Com)
- Masters of Computer Application (MCA)
- Masters of Education (M.Ed)
- Masters of Law (LLM)
- Master of Philosophy (M.Phil)
- Masters of Science (M.Sc)
- Masters of Technology (M.Tech)
- Post Graduate Diploma in Management (PGDM)
- PG Medical (MD / MS / DM / MCh)
- PG Dental (MDS)

### More

- Doctor of Philosophy (Ph.D)
- Integrated / Dual Degree
- Diploma
- PG Diploma

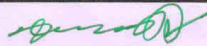

N. Adivishnu

  
PRINCIPAL  
GOVT. DEGREE COLLEGE  
GAMBHIRAOPET-505304  
RAJANNA SIRCILLA (DIST).S.

GOVERNMENT DEGREE COLLEGE, GAMBHIRAOPET  
RAJANNA SIRCILLA DIST  
TELANGANA

**DEPARTMENT OF PHYSICS**



Career guidance awareness to students.

*N. Adivishnu*  
Course coordinator

*[Signature]*  
Principal  
PRINCIPAL  
GOVT. DEGREE COLLEGE  
GAMBHIRAOPET-505304  
RAJANNA SIRCILLA (DIST) T.S.



GOVERNMENT DEGREE COLLEGE, GAMBHIRAOPET  
RAJANNA SIRCILLA DIST  
TELANGANA

**DEPARTMENT OF PHYSICS**

**Report on Career guidance programme**



In view of showing and enlightening the students of physical science by exploring different career prospects of education and employment with a clear explanation as per the opportunities from graduation and post graduation including diplomas, P.G diplomas and certificate courses.

The students are greatly provided an irradiating job opportunities specially focusing on the subject of physics to be a part in state, central, corporate and private sector in the elevation of scientific advancement of the nation.

The students felt it benefited largely with this programme and decided to move forward to achieving P.G seats in central universities and premier institutions of excellence to crack wonderful jobs.

*N. Adivishnu*  
Course coordinator

*[Signature]*  
Principal

PRINCIPAL  
GOVT. DEGREE COLLEGE  
GAMBHIRAOPET-505304  
RAJANNA SIRCILLA (DIST)T.S.

GOVERNMENT DEGREE COLLEGE, GAMBHIRAOPET  
RAJANNA SIRCILLA DIST

DEPARTMENT OF ECONOMICS

PERMISSION LETTER

Date:16-09-2018

To  
The Principal,  
Government Degree College,  
Gambhiraopet,  
Rajanna Sircilla Dist.-506304



Respected Sir,

Sub:- Department of Economics - Seeking Permission to conduct career guidance programme in our college Request-Reg.

-o0o-

*Permitted*  
*[Signature]*

The faculty of Department of Economics would like to bring to your kind notice that the department of Economics would like to conduct the career guidance programme for the academic year 2018-2019 for the betterment of all students.

Hence, I request you to permit to conduct the career guidance programme for the above mentioned academic year.

Thanking you sir,

Yours faithfully

*[Signature]*  
B.SRINIVAS

In-charge  
Department of Economics

**GOVERNMENT DEGREE COLLEGE GAMBHIRAOPET  
DEPARTMENT OF ECONOMICS**

CIRCULAR

Date: 07-09-2018

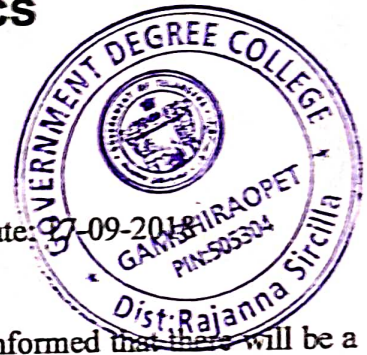

All the UG- I, II and III YEAR students of this college are informed that there will be a career guidance programme in the department of Economics on 18-09-2018 at 1:30 pm. Hence all are instructed to attend the career guidance programme without fail.

  
Signature of the lecturer

  
Principal  
PRINCIPAL  
GOVT. DEGREE COLLEGE  
GAMBHIRAOPET-505304  
RAJANNA SIRCILLA (DIST)T.S.

**GOVERNMENT DEGREE COLLEGE GAMBHIRAOPET  
RAJANNA SIRILLA DIST  
DEPARTMENT OF ECONOMICS**



Student attendance sheet:

Sl.No	Name of the student	CLASS AND YEAR	College ID	Signature of student
1	A.ARJUN	BAIII YEAR	16077086129501	A.Arjun
2	A.MOUNIKA	BAIII YEAR	16077086129502	A.Mounika
3	R.MOUNIKA	BAIII YEAR	16077086129509	R.Mounika
4	G.JAYA	BAIII YEAR	16077086129507	G.Jaya
5	M.SANTHOSH	BAIII YEAR	16077086129508	M.Santhosh
6	B.DEVILAL	BAIII YEAR	16077086129505	B.Devilal
7	D.SOUMYA	BAII YEAR	17077086129503	D.Soumya
8	M.KALYANI	BAII YEAR	17077086129505	M.Kalyani
9	M.LATHA	BAII YEAR	17077086129506	M.LATHA
10	N.NIRMALA	BAII YEAR	17077086129507	N.Nirmala
11	P.NARESH	BAII YEAR	17077086129508	P.Naresh
12	S.MAHENDER	BAII YEAR	17077086129511	S.Mahender
13	P.ROHITH	BAII YEAR	17077086129509	P.Rohith
14	SUMEHA	BAII YEAR	17077086129512	Sumeha
15	V.ANJALIAH	BAII YEAR	17077086129513	V.Anjali
16	A.SWAPNA	BAI YEAR	18077086129001	A.Swapna
17	B.PRAVEEN	BAI YEAR	18077086129003	B.Praveen
18	CH. SRUJAN	BAI YEAR	18077086129006	Ch.Srujan
19	CH.REKHA	BAI YEAR	18077086129005	Ch.Rekha
20	K.REKHA	BAI YEAR	18077086129008	M.Dasu
21	M.DASU	BAI YEAR	18077086129012	M.Dasu
22	B.RAJU	BAI YEAR	18077086129501	B.Raju
23	G.HARIDAS	BA I YEAR	18077086129503	G.Haridas
24	G.MEENA	BA I YEAR	18077086129504	G.Meena
25	P.SAVITHA	BA I YEAR	18077086129508	P.Savitha
26	B.BAVANI	BSC BZC III YEAR	16077086445501	B.Bavani
27	B.VINITH KUMAR	BSC MPC III YEAR	16077086445502	B.Vinith Kumar
28	B.SRINIVAS	BSC MPC III YEAR	16077086445503	B.Srinivas
29	B.VENNELA	BSC BZC III YEAR	16077086445504	B.Venneke
30	CH.DIVYA	BSC BZC III YEAR	16077086445505	Ch.Divya
31	M.SHIVANI	BSC BZC III YEAR	16077086445507	M.Shivani
32	M.ANUSHA	BSC BZC III YEAR	16077086445508	M.Anusha
33	V.SRIKANTH	BSC BZC III YEAR	16077086445510	V.Srikanth
34	Y.MADHUKAR	BSC BZC III YEAR	16077086445511	Y.Madhukar
35	JELLA AJAY	BSC MPC III YEAR	16077086441501	J.Ajay
36	CH. VANAJA	B.COM III YEAR	16077086401504	Ch.Vanaja
37	K.SWATHI	B.COM III YEAR	16077086401511	K.Swathi
38	PITLA.DEEPA	B.COM III YEAR	16077086401520	P.Deepa
39	M.SANDHYA	B.COM III YEAR	16077086401516	M.Sandhya
40	R.VISHNU	B.COM III YEAR	16077086401521	R.Vishnu

*Bhava*  
Signature of The Lecturer

*[Signature]*  
**PRINCIPAL**  
GOVT. DEGREE COLLEGE  
GAMBHIRAOPET-505304  
RAJANNA SIRILLA (DIST)T.S.

41	A.JAYA	BSC BZC II YEAR	17077086445501	A.Jaya
42	B.SRIKANTH	BSC BZC II YEAR	17077086445502	B.Srikanth
43	G.MADHU	BSC BZC II YEAR	17077086445507	G.Madhu
44	K.SWAPNA	BSC BZC II YEAR	17077086445509	K.Swapna
45	M.KALPANA	BSC BZC II YEAR	17077086445511	M.Kalpna



*[Handwritten signature]*

signature of the lecturer

*[Handwritten signature]*

Principal  
 PRINCIPAL  
 GOVT. DEGREE COLLEGE  
 GAMBHIRAOPET-505304  
 RAJANNA SIRICILLA (DIST)T.S.

**GOVERNMENT DEGREE COLLEGE GAMBHIRAOPET**  
**DEPARTMENT OF ECONOMICS**  
**CAREER GUIDANCE PROGRAMME**



TOPIC : PG ENTRANCE  
&  
STATE SERVICES GUIDANCE

DATE : 18-09-2018

RESOURCE PERSON : B.SRINIVAS

LECTURER IN ECONOMICS AND INCHARGE  
DEPT OF ECONOMICS  
GDC GAMBHIRAOPET

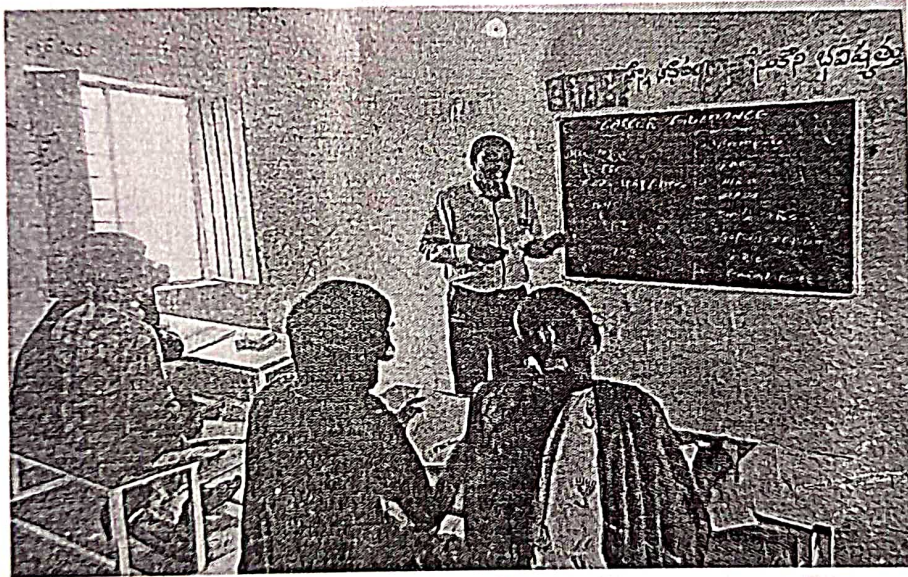

*B. Srinivas*  
Signature of the lecturer

*[Signature]*  
Principal  
PRINCIPAL  
GOVT. DEGREE COLLEGE  
GAMBHIRAOPET-505304  
RAJANNA SIRCILLA (DIST) T.S.

# Department of Economics

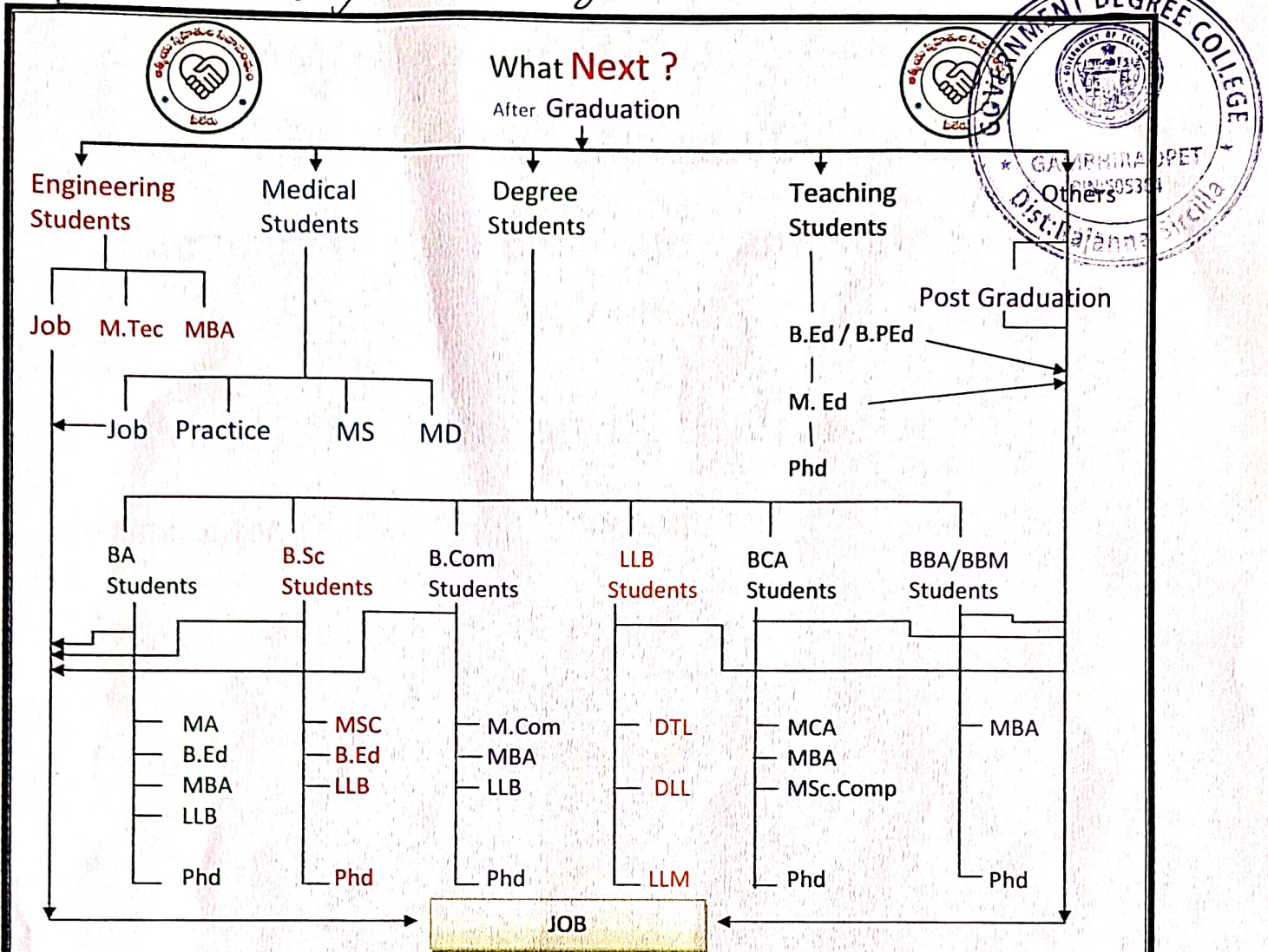

Post Graduation Course	Eligibility
MA Telugu	Any degree with one subject Telugu
MA English	Any degree with one subject English
MA Hindi	Any degree with one subject Hindi
MA Economics	BA with Economics one of the sub.
MA History	BA with History one of the sub.
MA Sociology	BA
MA Political Sci.	BA
MA Public Adm.	BA.
MS. Public rel.	BA
M.Sc Computers	B.Sc Comp / B.Com Comp / BA Comp / BCA
M.Com	B.Com/ BA with Commerce one of the subject.
MCA	BA/B.Sc with Maths.
MBA	Any degree
MA Archaeolog	BA

Post Graduation Course	Eligibility
M.Sc Maths	B.Sc / BA with one subject Maths
M.Sc Chemistry	B.Sc with Chemistry
M.Sc Botany	B.Sc with Botany
M.Sc Zoology	B.Sc with Zoology
M.Sc Physics	B.Sc with Physics
M.Sc Home Sci.	B.Sc with Botany + Zoology
M.Sc Anthropol	B.Sc with Zoology / BA
M.Sc Psychology	Any degree
M.Sc Bio-Chemis	B.Sc with one subject Chemi
M.Sc Bio-Tecno	B.Sc with one subject Bio-Tecnology
M.Sc Micro biolo	B.Sc with Zoology
MSc Virology	B.Sc with Zoology
MLIC	BLIC
LLM	BL / LLB

*Detailed chart for Higher Education after Graduation*

  
**PRINCIPAL**  
 GOVT. DEGREE COLLEGE  
 GAMBHIRAOPET-505304  
 RAJANNA SIRCILLA (DIST)T.S.

GOVERNMENT DEGREE COLLEGE GAMBHIRAOPET

RAJANNA SIRICILLA DIST

Summary of the PG entrance and state services  
guidance

DEPARTMENT OF ECONOMICS



Name of the Department: ECONOMICS

Date of Career guidance : 18-09-2018

Topic : PG Entrance & State services

guidance

Resource person : B. SRINIVAS

No. of Hours of taken : 1.30pm to 3.30pm

NO. OF STUDENTS ATTENDED : 45

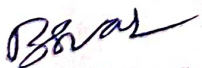
  
Signature of the lecturer

  
principal

PRINCIPAL  
GOVT. DEGREE COLLEGE  
GAMBHIRAOPET-505304  
RAJANNA SIRICILLA (DIST) T.S.



**GOVERNMENT DEGREE COLLEGE, GAMBHIRAOPET  
RAJANNA SIRCILLA DIST**

**DEPARTMENT OF ECONOMICS**

**PERMISSION LETTER**

Date: 29-01-2018

To  
The Principal,  
Government Degree College,  
Gambhiraopet,  
Rajanna Sircilla Dist.-506304



Respected Sir,

Sub:- Department of Economics - Seeking Permission to conduct career guidance programme in our college Request-Reg.

-o0o-

*Permit*  
*[Signature]*

The Faculty of Department of Economics would like to bring to your kind notice that the department of Economics would like to conduct the career guidance programme for the academic year 2017-18 for the betterment of all students.

Hence, I request you to permit to conduct the career guidance programme for the above mentioned academic year.

Thanking you sir,

Yours faithfully

*[Signature]*

B.SRINIVAS

In-charge

Department of Economics

**GOVERNMENT DEGREE COLLEGE GAMBHIRAOPET  
DEPARTMENT OF ECONOMICS**

CIRCULAR

Date: 30-01-2018

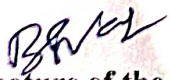

All the UG- I, II and III YEAR students are informed that there will be an career guidance programme in department of Economics on 01-02-2018 at 1:30 pm..Hence all are instructed to attend the career programme without fail.

  
Signature of the lecturer

  
Principal  
PRINCIPAL  
GOVT. DEGREE COLLEGE  
GAMBHIRAOPET-505304  
RAJANNA SIRCILLA (DIST)T.S.

GOVERNMENT DEGREE COLLEGE GAMBHIRAOPET

RAJANNA SIRILLA DIST

DEPARTMENT OF ECONOMICS

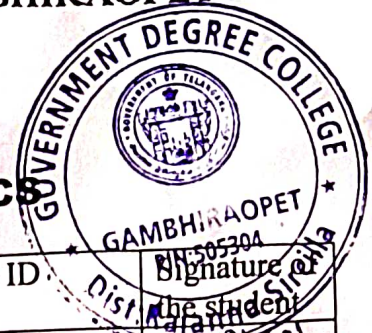

Student attendance sheet:

Sl.No	Name of the student	CLASS AND YEAR	College ID	Signature of the student
1	B.NIKHILA	BAIII YEAR	708615129502	B. Nikhila
2	B.SWAPNA	BAIII YEAR	708615129503	B. Swapna
3	K.RAJITHA	BAIII YEAR	708615129504	K. Rajitha
4	B.VANITHA	BAIII YEAR	708615129505	B. Vanitha
5	G.BARATHI	BAIII YEAR	708615129516	G. Barathi
6	B.SWAPNA	BAIII YEAR	708615129511	B. Swapna
7	D.SUNITHA	BAIII YEAR	708615129512	D. Sunitha
8	A.MOUNIKA	BAIII YEAR	708615129515	A. Mounika
9	R.MOUNIKA	BAII YEAR	16077086129509	R. Mounika
10	G.JAYA	BAII YEAR	16077086129507	G. JAYA
11	A.MOUNIKA	BAII YEAR	16077086129502	A. Mounika
12	B.DEVILAL	BAII YEAR	16077086129505	B. Devilal
13	M.SANTHOSH	BAII YEAR	16077086129508	M. Santhosh
14	A.ARJUN	BAII YEAR	16077086129501	A. Arjun
15	D.SOUMYA	BAI YEAR	17077086129503	D. Soumya
16	M.KALYANI	BAI YEAR	17077086129505	M. Kalyani
17	M.LATHA	BAI YEAR	17077086129506	M. Latha
18	N.NIRMALA	BAI YEAR	17077086129507	N. Nirmala
19	SUMEHA	BAI YEAR	17077086129512	Sumeha
20	P.NARESH	BAI YEAR	17077086129508	P. Nares
21	P.ROHITH	BAI YEAR	17077086129509	P. Rohith
22	S.MAHENDER	BAI YEAR	17077086129511	S. Mahender
23	T.SRILATHA	BSC BZC III YEAR	708615445501	T. Sri Latha
24	D.JYOTHI	BSC BZC III YEAR	708615445502	D. Jyothi
25	P.NAVEEN	BSC BZC III YEAR	708615445503	P. Naveen
26	T.SWATHI	BSC BZC III YEAR	708615445504	T. Swathi
27	G.NIKHL KUMAR	BSC BZC III YEAR	708615445505	G. Nikhil Kumar
28	Y.BARGAVI	BSC BZC III YEAR	708615445506	Y. Bargavi
29	B.SRIKANTH	BSC BZC III YEAR	708615445507	G. Srikanth
30	G.SRIKAR	BSC BZC III YEAR	708615445508	G. Srikar
31	B.R.VIKRAM GANDHI	BSC MPC III YEAR	708615441507	B.R. Vikram Gandhi
32	B.RAJASHEKAR	BSC MPC III YEAR	708615441508	B. Rajashekar

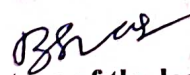
  
Signature of the lecturer

  
Principal  
PRINCIPAL  
GOVT. DEGREE COLLEGE  
GAMBHIRAOPET-505304  
RAJANNA SIRILLA (DIST) T.S.

**GOVERNMENT DEGREE COLLEGE GAMBHIRAOPET**  
**DEPARTMENT OF ECONOMICS**  
**CAREER GUIDANCE PROGRAMME**

TOPIC : PG ENTRANCE&GROUPS GUIDANCE

DATE : 01-02-2018

RESOURCE PERSON: B.SRINIVAS

LECTURER IN ECONOMICS

GDC GAMBHIRAOPET

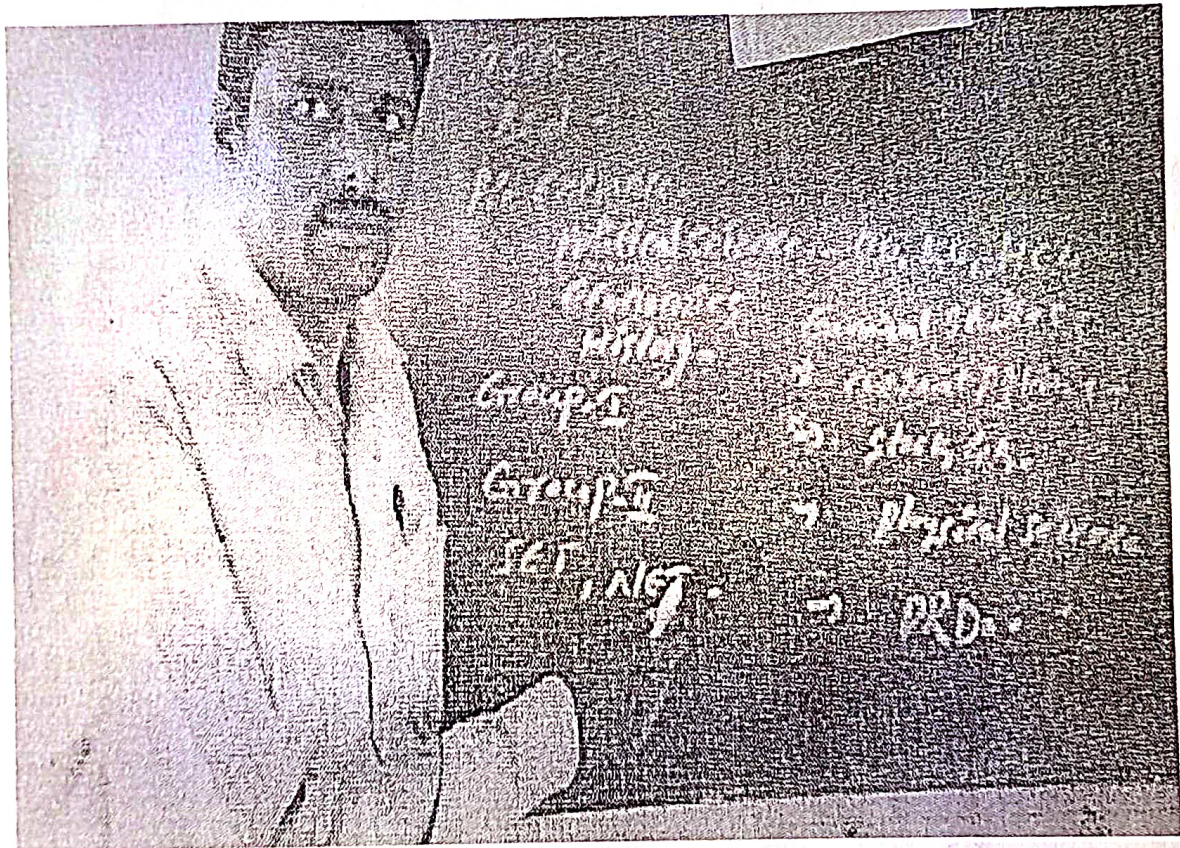

*B.Srinivas*  
Signature of the lecturer  
*B.Srinivas*

*[Signature]*  
PRINCIPAL  
GOVT. DEGREE COLLEGE  
GAMBHIRAOPET-505304  
RAJANNA SIRICILLA (DIST).T.S.

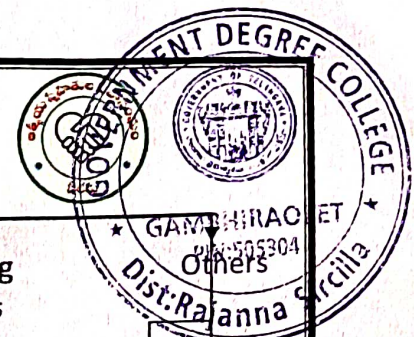

### What Next ?

After Graduation

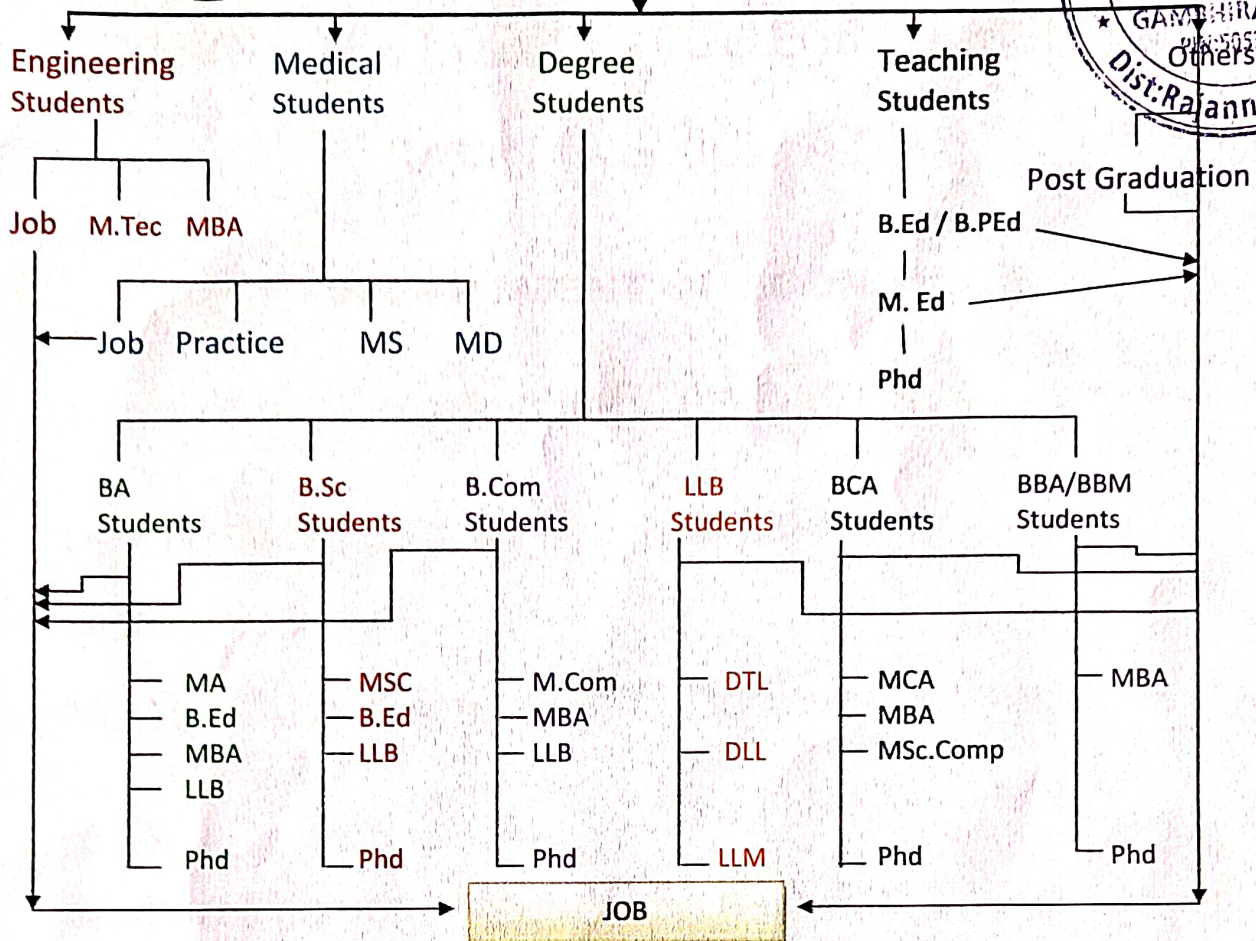

Post Graduation Course	Eligibility
MA Telugu	Any degree with one subject Telugu
MA English	Any degree with one subject English
MA Hindi	Any degree with one subject Hindi
MA Economics	BA with Economics one of the sub.
MA History	BA with History one of the sub.
MA Sociology	BA
MA Political Sci.	BA
MA Public Adm.	BA.
MS. Public rel.	BA
M.Sc Computers	B.Sc Comp / B.Com Comp / BA Comp / BCA
M.Com	B.Com/ BA with Commerce one of the subject.
MCA	BA/B.Sc with Maths.
MBA	Any degree
MA Archaeolog	BA

Post Graduation Course	Eligibility
M.Sc Maths	B.Sc / BA with one subject Maths
M.Sc Chemistry	B.Sc with Chemistry
M.Sc Botany	B.Sc with Botany
M.Sc Zoology	B.Sc with Zoology
M.Sc Physics	B.Sc with Physics
M.Sc Home Sci.	B.Sc with Botany + Zoology
M.Sc Anthrop	B.Sc with Zoology / BA
M.Sc Psychology	Any degree
M.Sc Bio-Chemis	B.Sc with one subject Chemi
M.Sc Bio-Tecno	B.Sc with one subject Bio-Tecnology
M.Sc Micro biolo	B.Sc with Zoology
MSc Virology	B.Sc with Zoology
MLIC	BLIC
LLM	BL / LLB

Detailed chart for higher education after Graduation

*[Signature]*  
**PRINCIPAL**  
 GOVT. DEGREE COLLEGE  
 GAMBHIRACPET-505304  
 RAJANNA SIRICILLA (DIST)T.S.

GOVERNMENT DEGREE COLLEGE GAMBHIRAOPET

RAJANNA SIRICILLA DIST

**DEPARTMENT OF ECONOMICS**



Name of the Department: ECONOMICS

Date of Career guidance : 01-02-2018

Name of the Topic : PG Entrance & Groups

Resource person : B.SRINIVAS

No. of Hours of taken : 1.30pm to 3.00pm

NO. OF STUDENTS ATTENDED : 32

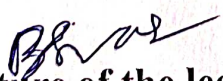
  
Signature of the lecturer

  
Principal  
PRINCIPAL  
GOVT. DEGREE COLLEGE  
GAMBHIRAOPET-505304  
RAJANNA SIRICILLA (DIST) T.S.

# **Government Degree College Gambhiraopet Rajanna sircilla Department of commerce 2021-2022**

## **Awareness programme on entrepreneurship awareness program**

Entrepreneurship awareness programme conducted by Entrepreneurship development cell on 26 February 2022. The MSME organisers explain about schemes and objectives of the MSME. The schemes of MSME are providing credit and financial assistance, skill development training infrastructure development ,marketing assistance technology upgrade.

The main objectives of this program are creating new jobs and reduce unemployment promote entrepreneurship culture in India gross routes economic development social needs and promote innovation to strength the competitiveness of MSME sector.

GDC Gambhiraopet

Rajanna Sircilla Dist

7

Date: 26/02/2022

Entrepreneurship Awareness programme for youth conducted by MSME organized on 26/02/2022. The organizer explained about MSME schemes and objectives. The schemes of this MSME are providing credit and financial assistance, skill development prog training, Infrastructure development, Marketing assistance, Technological and quality upgradation.

The main objectives of this programme are creating new jobs and reduce unemployment, promote entrepreneurship culture in India, Grassroots economic development, facilitate business solutions for unmet social needs, and promote innovation to strengthen the competitiveness of MSME sector.

Signatures of the  
Organisers.

1. Janak (P.V. Dasavath)   
 9948335898

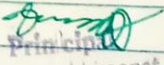
  
Principal  
G.D.C. Gambhiraopet  
Dist. Rajanna Sircilla-505301

2. M. Suresh  
9603395570



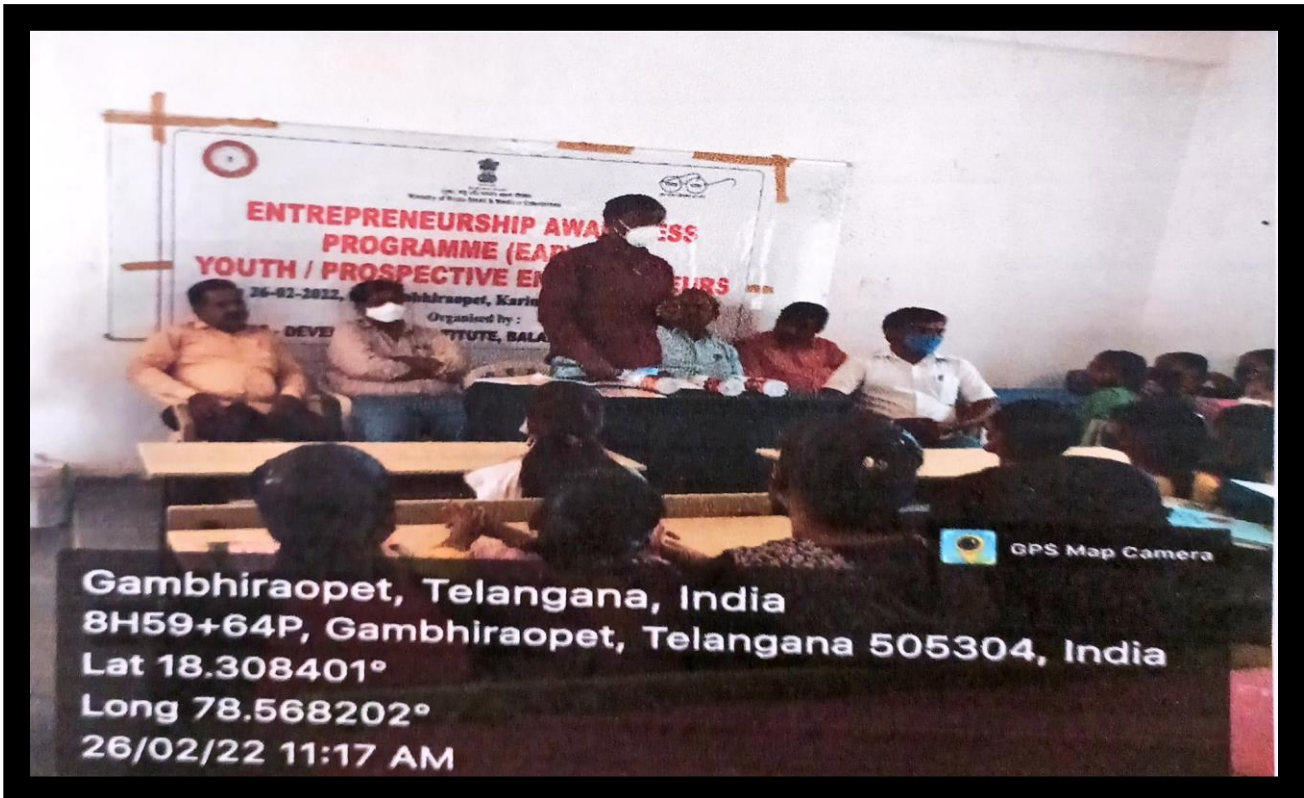

Gambhiraopet, Telangana, India  
8H59+64P, Gambhiraopet, Telangana 505304, India  
Lat 18.308401°  
Long 78.568202°  
26/02/22 11:17 AM



Gambhiraopet, Telangana, India  
8H59+64P, Gambhiraopet, Telangana 505304, India  
Lat 18.308396°  
Long 78.568212°  
26/02/22 11:17 AM

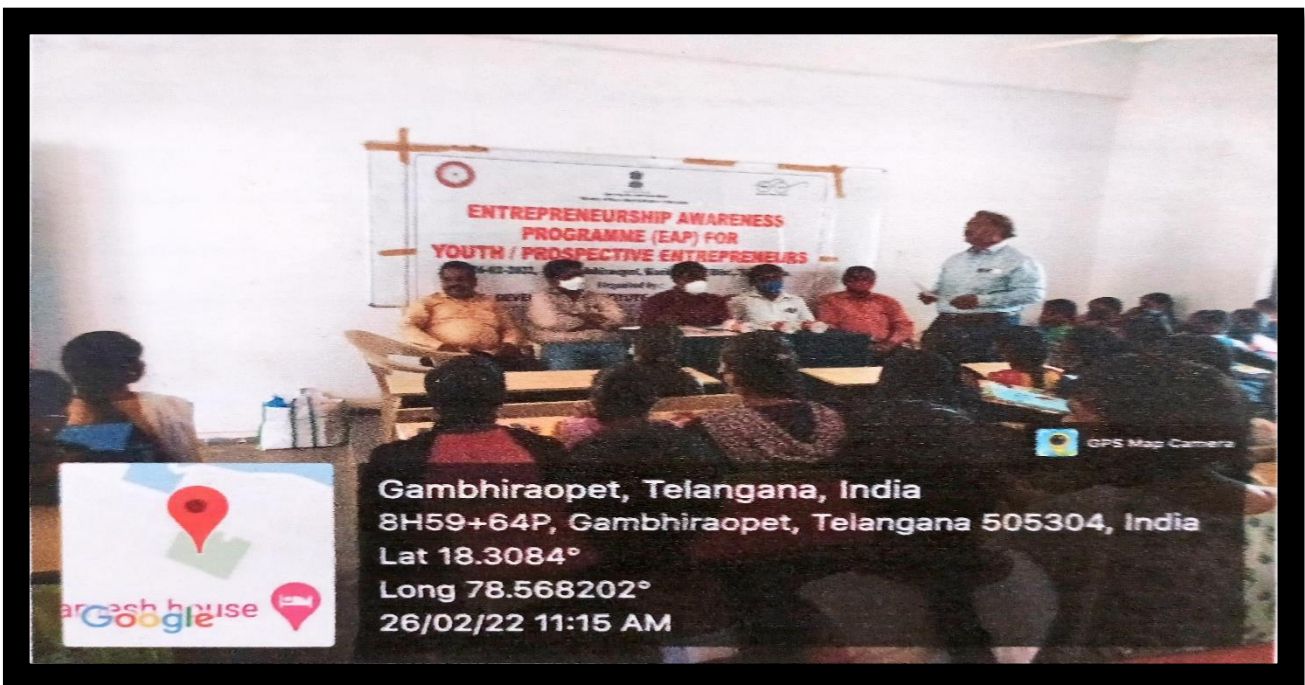

Gambhiraopet, Telangana, India  
8H59+64P, Gambhiraopet, Telangana 505304, India  
Lat 18.3084°  
Long 78.568202°  
26/02/22 11:15 AM



Govt. Degree College Gambhiraopet, Rajanna Siricilla (Dist)  
 Entrepreneurship Development Programe Organised by Department of  
 Economics & Commerce

Sl. No.	H.T. NO.	Name	Group	Signature
1	20077086402250	M. Kamya	B.com(CA)	Kamya
2	20077086402091	U. Bhavani	B.com(CA)	Bhavani
3	20077172402249	M. Ashwini	B.com(CA)	Ashwini
4	20077086402011	B. Ravali	B.com(CA)	B. Ravali
5	20077086402063	N. Ishwarya	B.com(CA)	N. Ishwarya
6	20077086402079	P. Sravani	B.com(CA)	P. Sravani
7	20077086402076	P. Sony	B.com(CA)	P. Sony
8	20077086402012	J. Bhavisha	B.com(CA)	J. Bhavisha
9	20077086402007	A. Aishwarya	B.com(CA)	A. Aishwarya
10	20077086402046	K. Ruchitha	B.com(CA)	K. Ruchitha
11	20077086402047	L. Shirisha	B.com(CA)	L. Shirisha
12	20077086402052	M. Shrevani	B.com(CA)	M. Shrevani
13	20077086402033	G. Sunitha	B.com(CA)	G. Sunitha
14	20077086402032	G. Deepsha	B.com(CA)	G. Deepsha
15	20077086402069	P. Ruchitha	B.com(CA)	P. Ruchitha
16	20077086402012	B. Kavya sri	B.com(CA)	B. Kavya sri
17	20077086402068	P. Ruchitha	B.com(CA)	P. Ruchitha
18	20077086402018	Ch. Archana	B.com(CA)	Ch. Archana
19	20077086402026	D. Bhavya	B.com(CA)	D. Bhavya
20	20077086402066	O. Babusha	B.com(CA)	O. Babusha
21	20077086402080	R. Susmitha	B.com(CA)	R. Susmitha
22	20077086402014	B. Poojitha	B.com(CA)	B. Poojitha
23	20077162402111	M. Mounika	B.com(CA)	M. Mounika
24	20077086402050	Shabena	B.com(CA)	Shabena
25	20077086402061	N. Divya	B.com(CA)	N. Divya
26	20077086402062	N. Divya	B.com(CA)	N. Divya
27	20077086402064	N. Prathvisha	B.com(CA)	N. Prathvisha
28	20077086402028	E. Ruchitha	B.com(CA)	E. Ruchitha
29	20077086402030	F. Bhavana	B.com(CA)	F. Bhavana
30	20077086402084	Saniya	B.com(CA)	Saniya
31	20077086402055	M. Anusha	B.com(CA)	M. Anusha
32	20077086402025	R. Shirisha	B.com(CA)	R. Shirisha
33	20077086402039	K. Anusha	B.com(CA)	K. Anusha
34	20077086402034	Strawiya	B.com(CA)	Strawiya
35				
36				
37	20077086402084	K. Sandhya	B.com(CA)	K. Sandhya
38				
39	20077089402025	S. Niphitha	B.com(CA)	S. Niphitha
40	20077089402004	M. Aparna	B.com(CA)	M. Aparna
41	200770864021090	P. Bhargavi	B.com(CA)	P. Bhargavi
42	200770864021063	M. Bhargavi	B.com(CA)	M. Bhargavi
43	200770864021022	B. Navitha	B.com(CA)	B. Navitha
44				
45				
46				

PRINCIPAL  
 GOVT. DEGREE COLLEGE  
 GAMBHIRAOPET-505304  
 RAJANNA SIRICILLA (DIST).S.

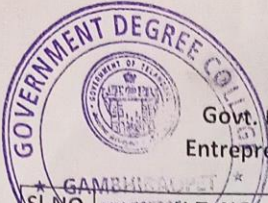

Govt. Degree College Gambhiraopet, Rajanna Siricilla (Dist)  
 Entrepreneurship Development Programe Organised by Department of  
 Economics & Commerce

Sl. No.	PIN:505304 H.T. NO.	Name	Group	Signature
1	210770864021074	N. Rakshitha	B.com CA	N. Rakshitha
2	210770864021009	A. Deepthi	B.com CA	A. Deepthi
3	210770864021045	G. Shalithi	B.com CA	G. Shalithi
4	210770864021096	S. Vidhayan	B.com CA	S. Vidhayan
5	210770864021004	G. Sallatha	B.com CA	G. Sallatha
6	210770864021094	S. Pranitha	B.com CA	S. Pranitha
7	210770864021113	T. Akhila	B.com CA	T. Akhila
8	210770864021066	K. Rekha	B.com CA	K. Rekha
9	210770864021049	K. Nigasi	B.com CA	K. Nigasi
10	210770864021109	T. Revathi	B.com CA	T. Revathi
11	210770864021021	B. Deepika	B.com CA	B. Deepika
12	210770864021085	P. Reekha	B.com CA	P. Reekha
13	210770864021090	Ch. Poaja	B.com CA	Ch. Poaja
14	210770864021093	S. Sandhya	B.com CA	S. Sandhya
15	210770864021089	P. Ramya	B.com CA	P. Ramya
16	210770864021083	D. Bhavitha	B.com CA	D. Bhavitha
17	210770864021092	R. Rachana	B.com CA	R. Rachana
18	210770864021077	N. Soumya	B.com CA	N. Soumya
19	210770864021106	S. Soumya	B.com CA	S. Soumya
20	210770864021069	N. Akhila	B.com CA	N. Akhila
21	210770864021047	J. Sudheep	B.com CA	J. Sudheep
22	210770864021066	MD. Sufyan	B.com CA	MD. Sufyan
23	210770864021067	MD. SUMER	B.com CA	MD. SUMER
24	210770864021068	MD. Bilal	B.com CA	MD. Bilal
25	210770864021086	N. Sulimran	B.com CA	N. Sulimran
26	210770864021081	P. Akshay	B.com CA	P. Akshay
27	210770864021065	MD. Sobail	B.com CA	MD. Sobail
28	210770864021069	M. Saiksha	B.com CA	M. Saiksha
29	210770864021110	T. Sameen	B.com CA	T. Sameen
30	210770864021030	D. Rakshitha	B.com CA	D. Rakshitha
31	210770864021001	A. RAJU	B.com CA	A. RAJU
32	210770864021101	S. Adithya	B.com CA	S. Adithya
33	210770864021087	P. Sathish	B.com CA	P. Sathish
34	210770864021112	T. Dileep	B.com CA	T. Dileep
35				
36				
37				
38				
39				
40				
41				
42				
43				
44				
45				
46				

PRINCIPAL  
 GOVT. DEGREE COLLEGE  
 GAMBHIRAOPET-505304  
 RAJANNA SIRICILLA (DIST) T.S.